

THE GENOME BROWSER – UNDER THE HOOD

GENOME BROWSER DEPENDENCIES

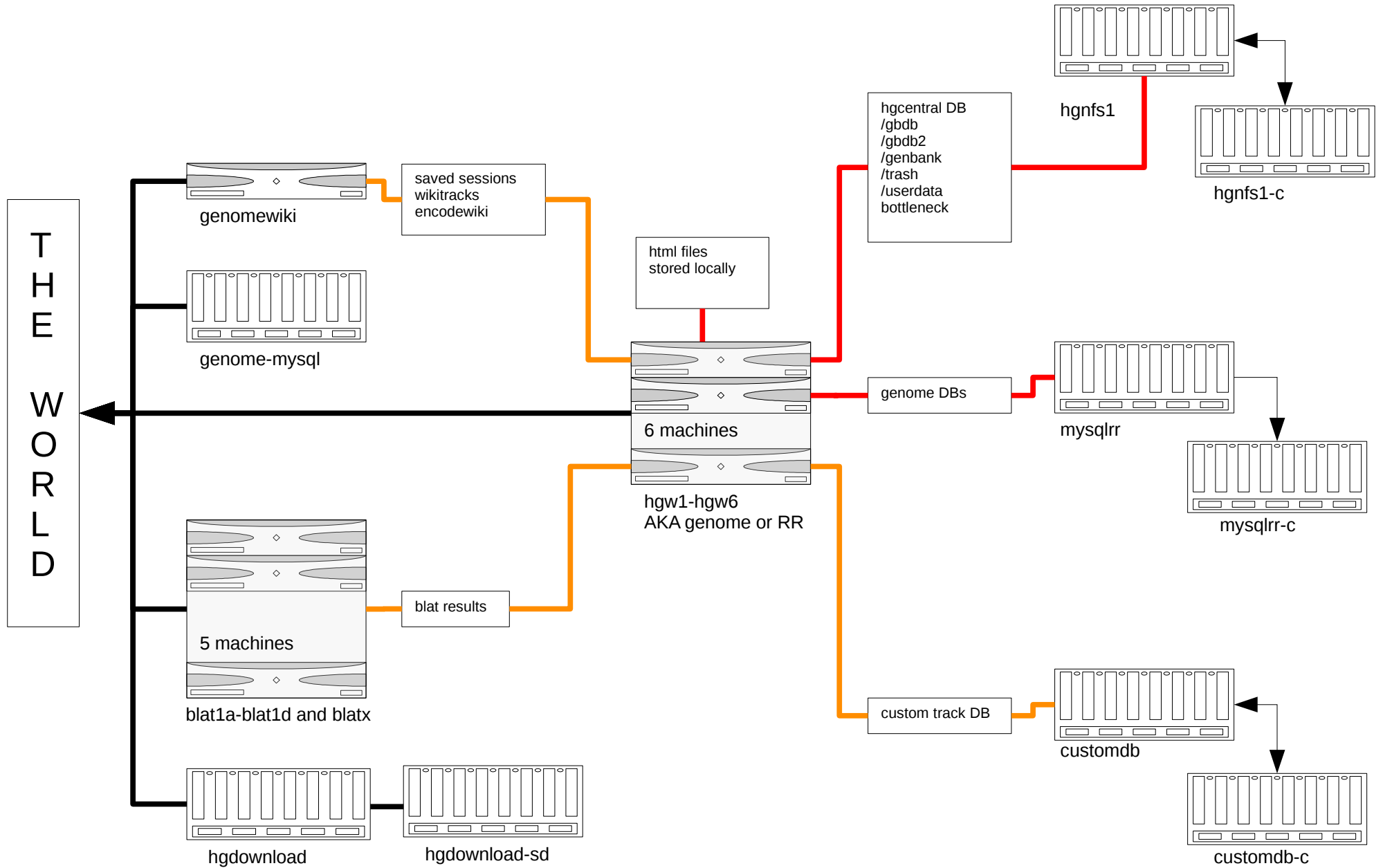

BETA TESTING DEPENDENCIES

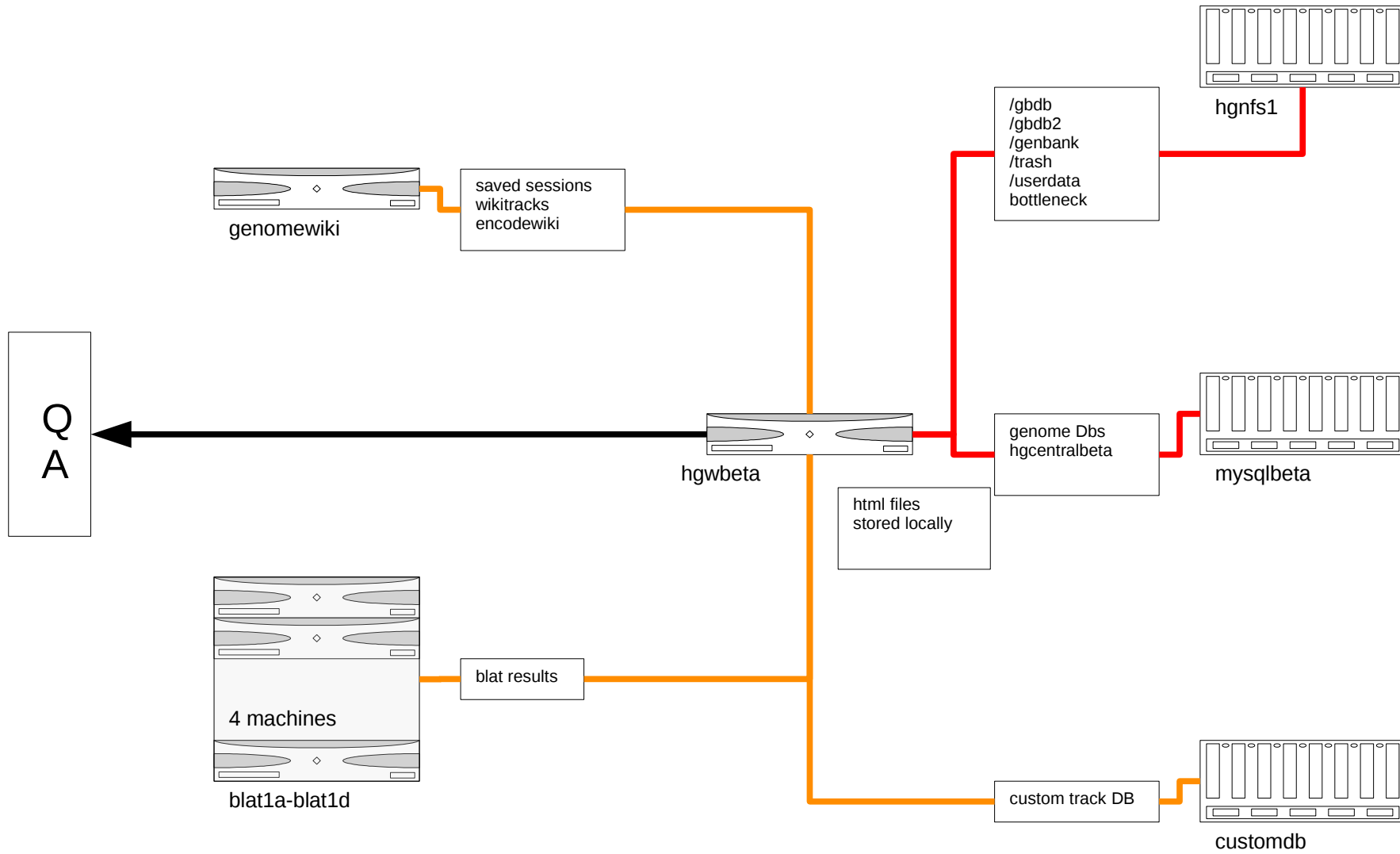

BROWSER DEVELOPMENT DEPENDENCIES

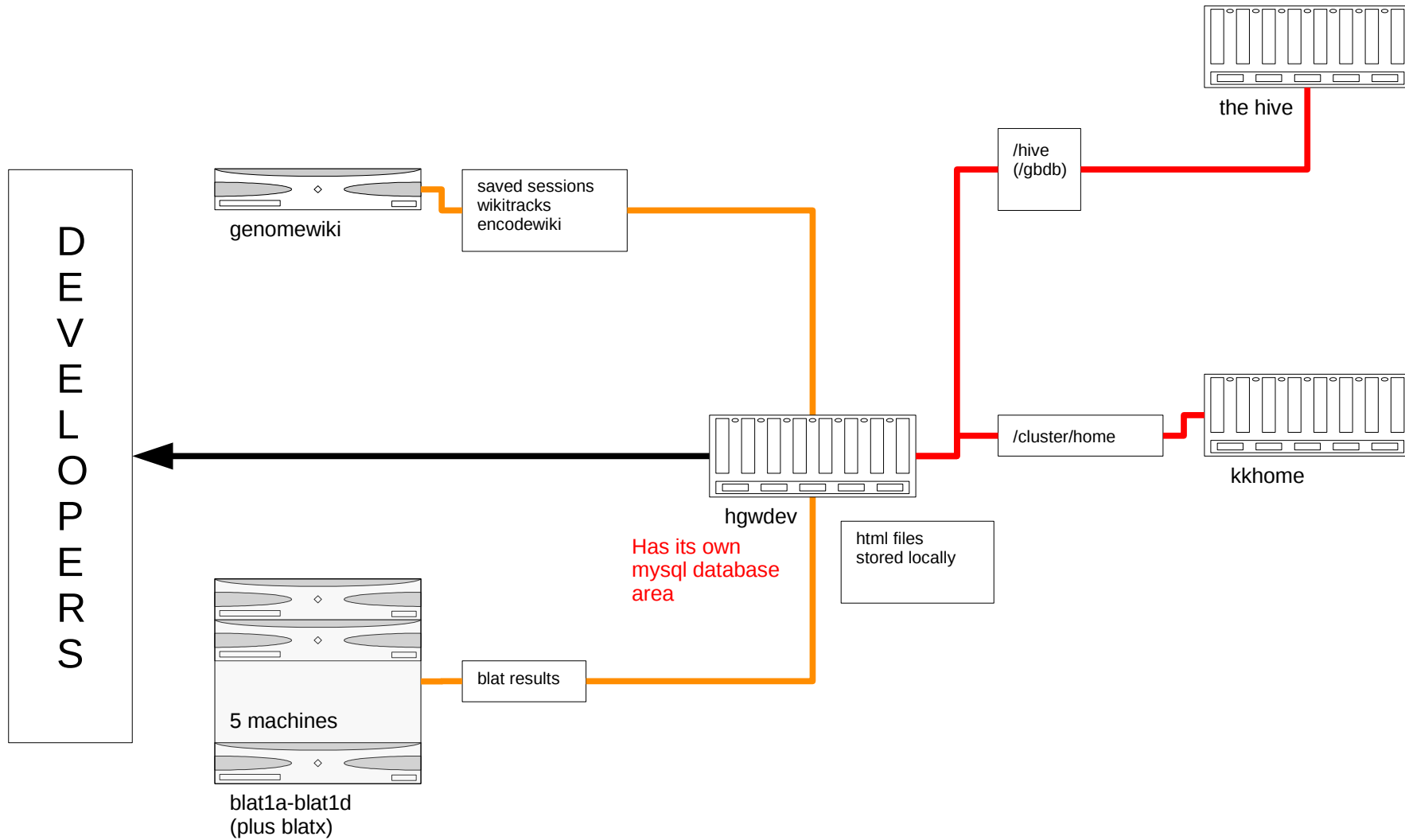

MYSQL DATA FLOW (EXCEPT HGCENTRAL)

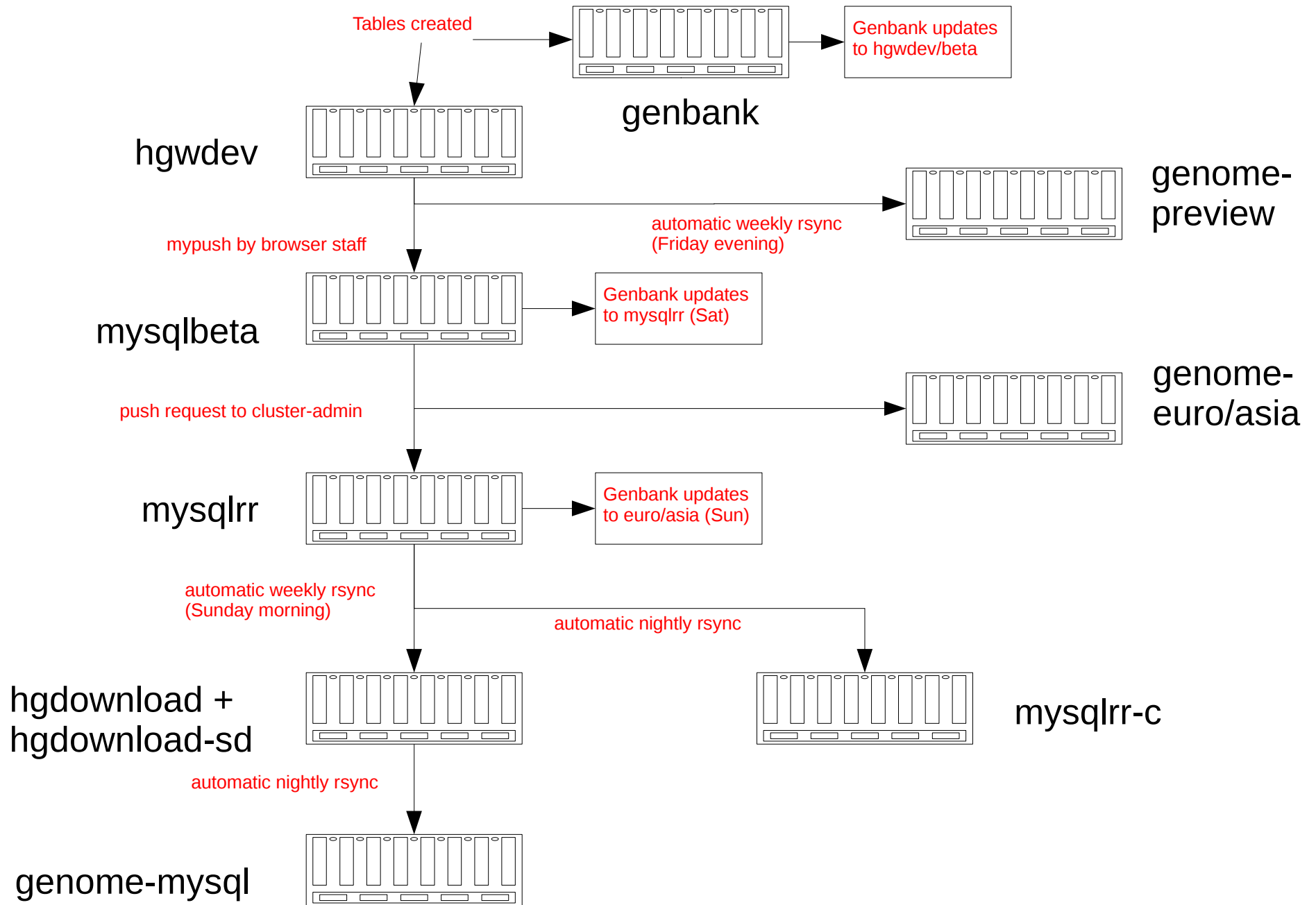

MYSQL HGCENTRAL FLOW

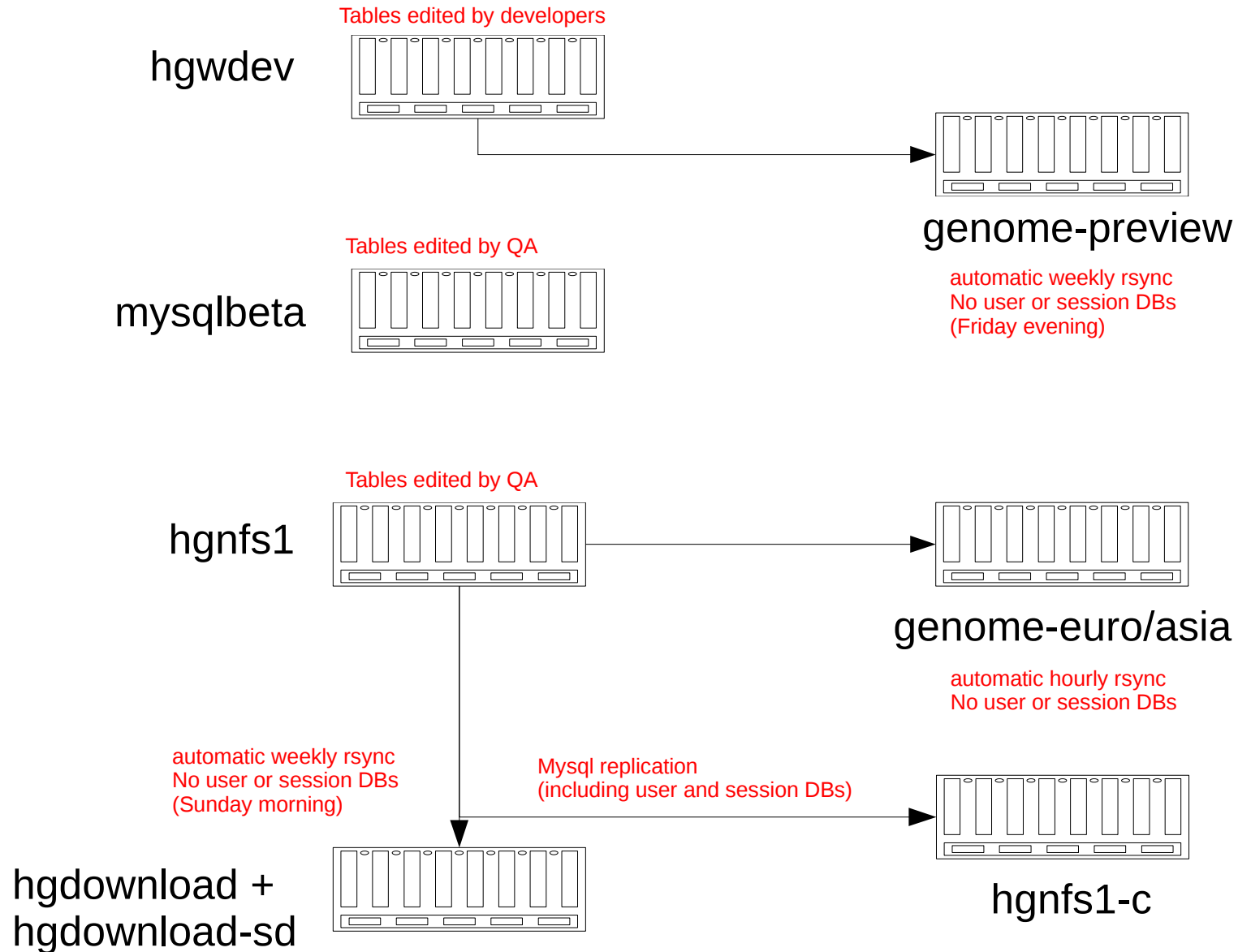

CGI DATA FLOW

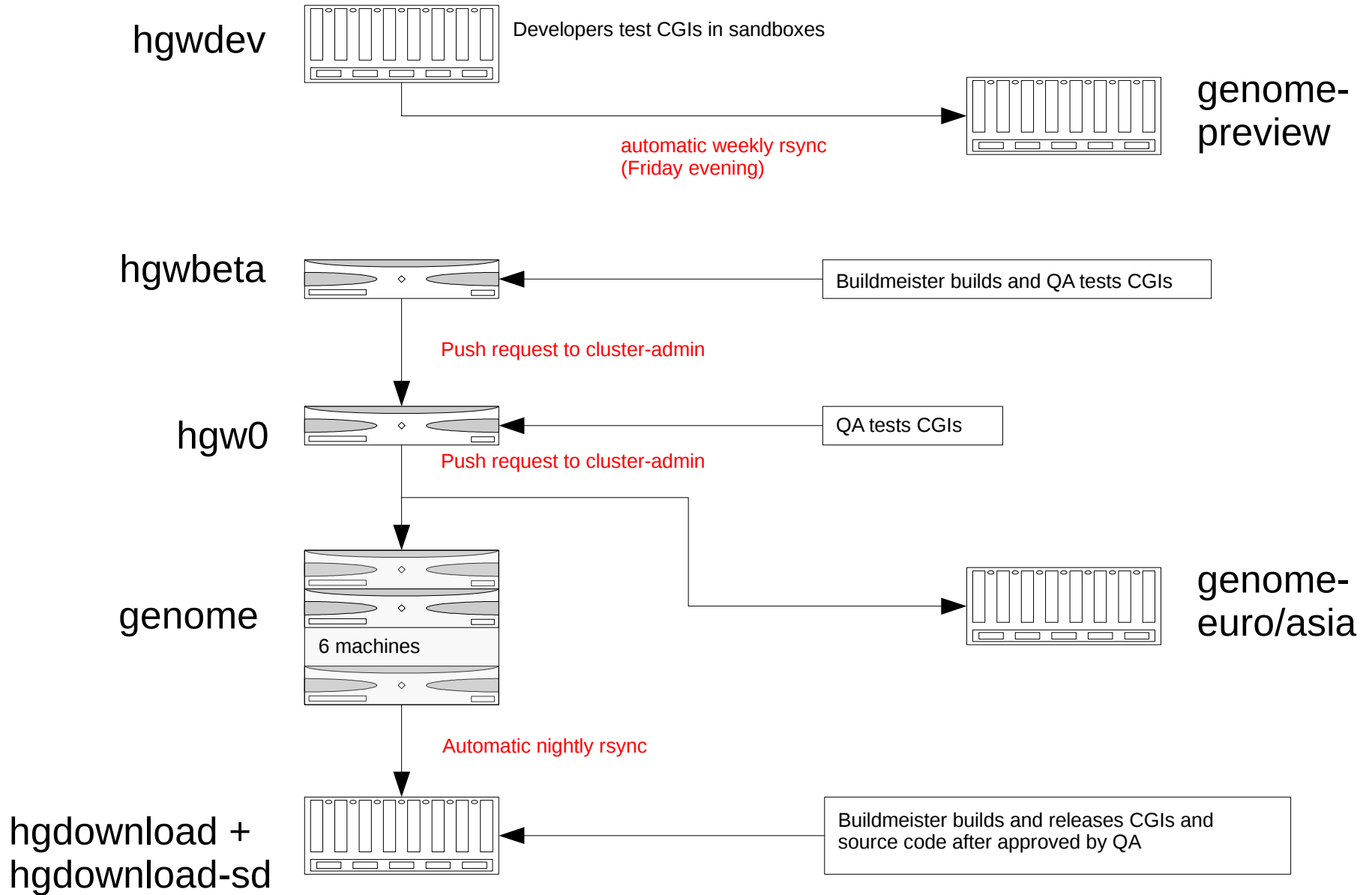

GBDB DATA FLOW

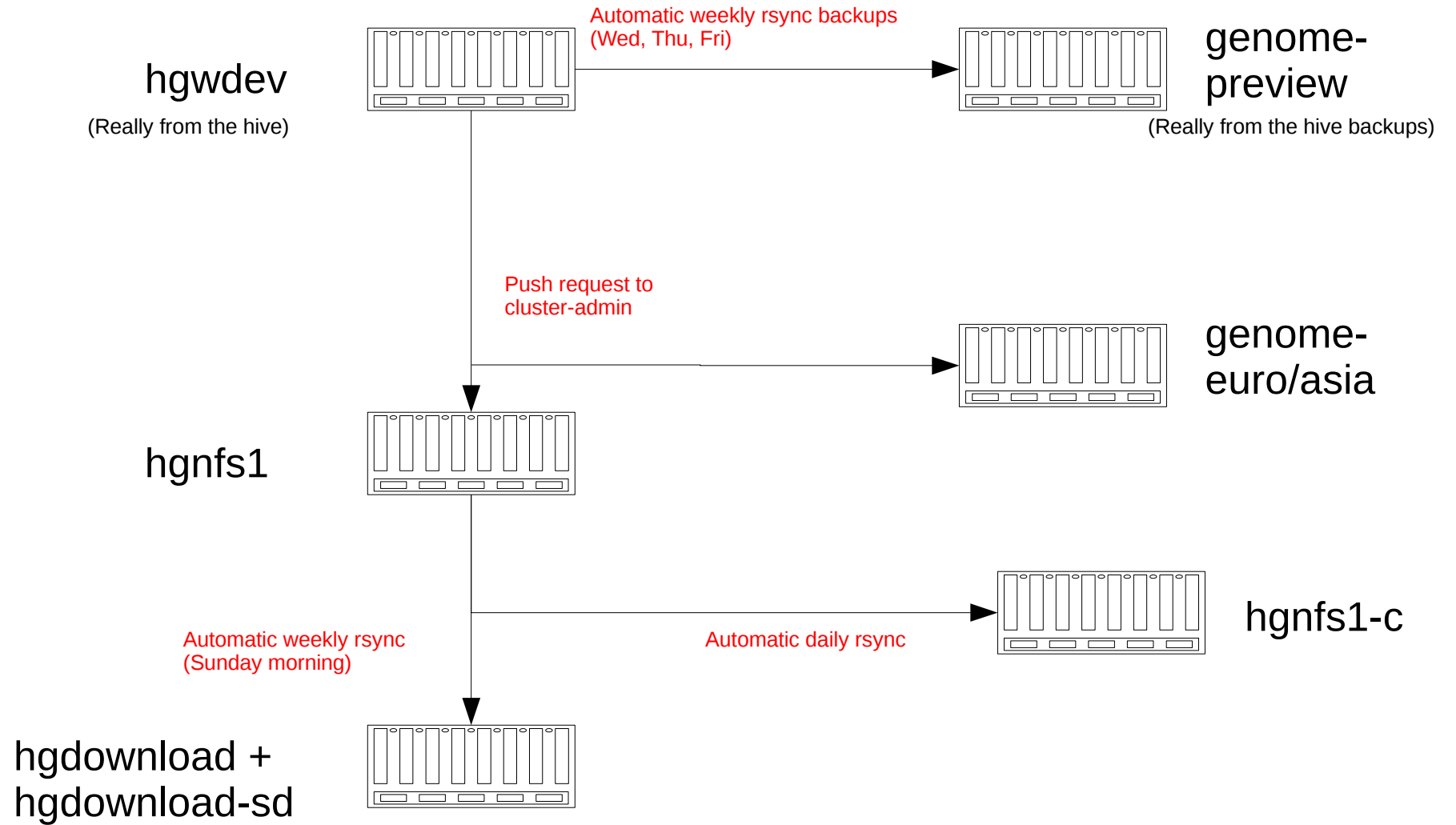

STATIC DOCS DATA FLOW

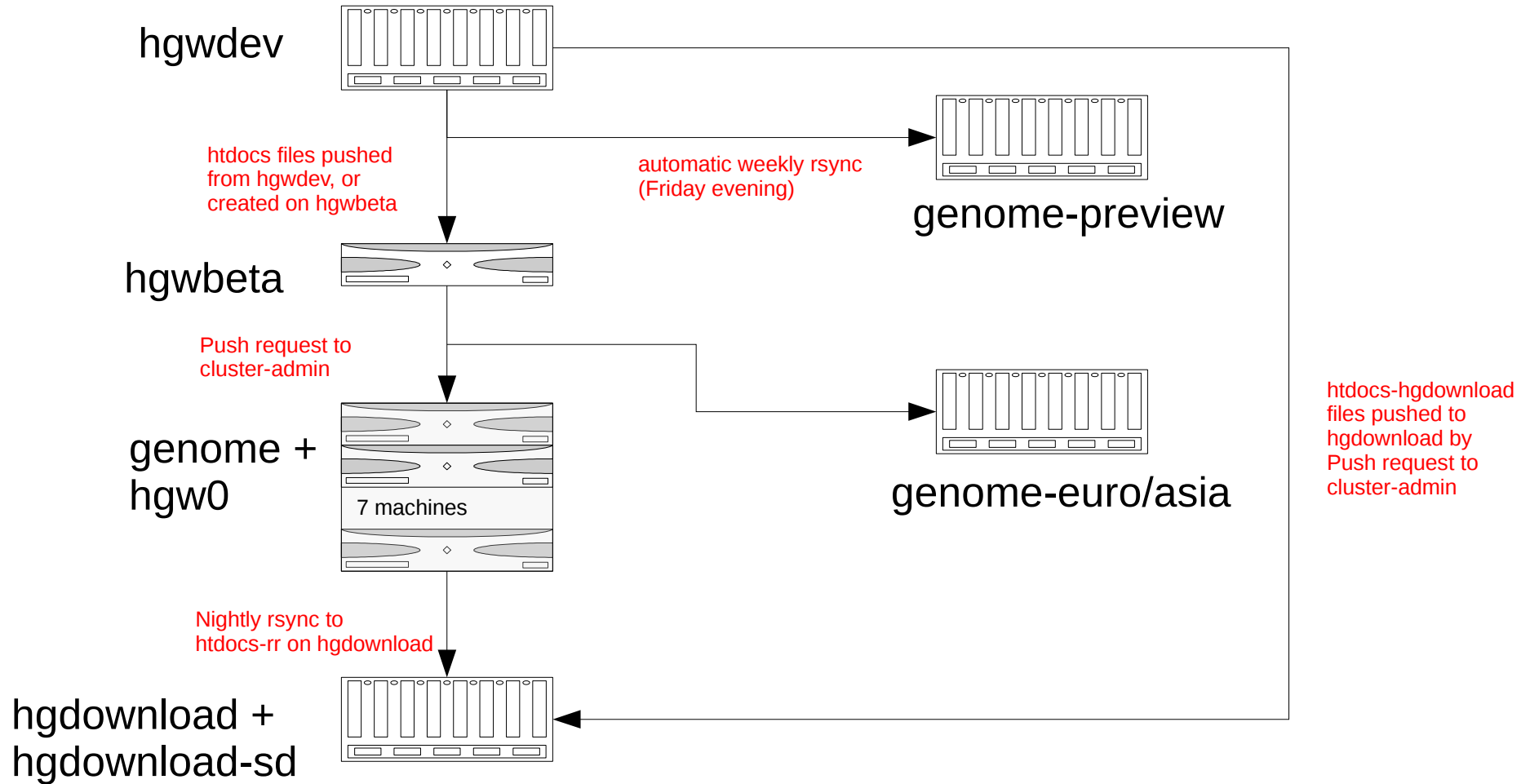

DOWNLOAD DATA FLOW

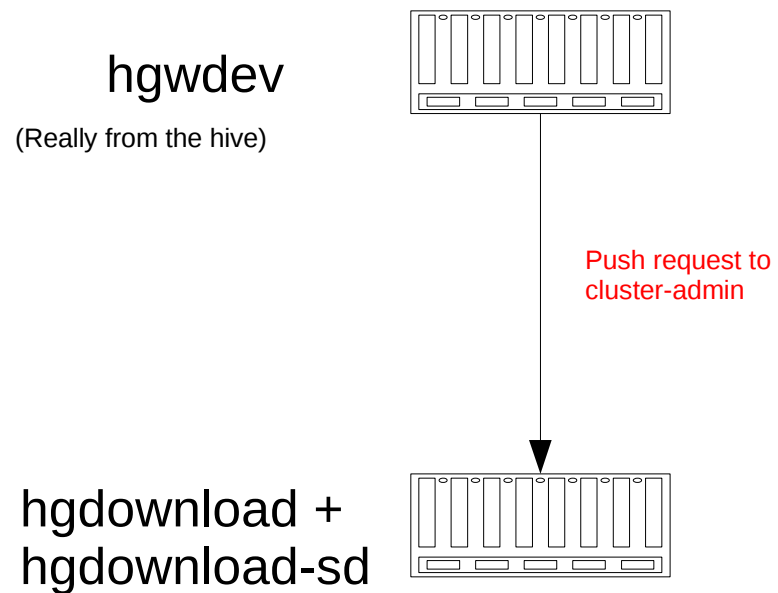

GBIB DEPENDENCIES

